

INSTRUCTION MANUAL

T119 DIN

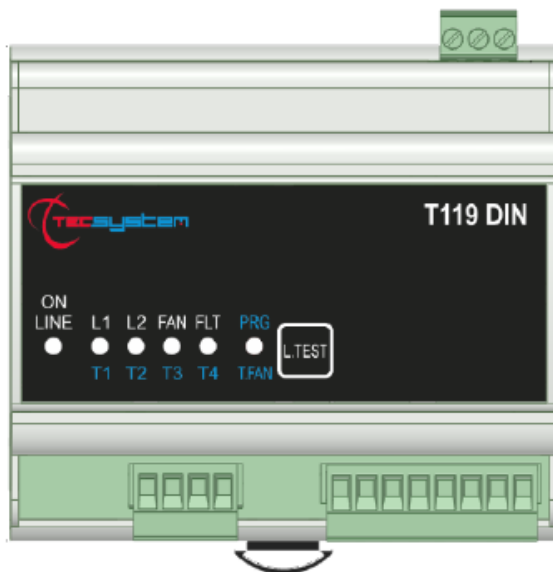

1MN0109 REV.1



operates with ISO9001 certified quality system

TECSYSTEM S.r.l.
20094 Corsico (MI)
Tel.: +39-024581861
Fax: +39-0248600783

<http://www.tecsystem.it>

R. 1.5 01/08/19

ENGLISH

“Translations of the original instructions”

INTRODUCTION

First of all we wish to thank you for choosing to use a **TECSYSTEM** product and recommend you read this instruction manual carefully: You will understand the use of the equipment and therefore be able to take advantage of all its functions.

ATTENTION! THIS MANUAL IS VALID AND COMPLETE FOR THE T119 DIN CONTROL UNIT

CONTENTS

	PAGE
1) SAFETY REQUIREMENTS	3
2) ACCESSORIES	4
3) TECHNICAL SPECIFICATIONS	5
4) INTRODUCTION	6
5) FRONT	7
• POWER SUPPLY	—
6) PROGRAMMING	8
• ALARM RELAY TEST	—
• LED TEST	9
• ALARM 1 RELAY OPERATION	—
• ALARM 2 RELAY OPERATION	—
• FAN RELAY OPERATION (VENTILATION)	—
• DELAYED VENTILATION CYCLE (DELAY ON)	—
• SENSOR DIAGNOSTIC DEVICE	10
• PTC SENSOR FAULT	—
• PTC SENSOR FAULT DIAGNOSIS	—
• "PTC" TYPE TEMPERATURE SENSORS	—
• PTC TECHNICAL SPECIFICATIONS	11
• PTC RESISTANCE VALUES ALLOWED FOR CONNECTION TO T119 DIN	—
7) SENSOR / RELAY ELECTRICAL CONNECTIONS	12
8) WARRANTY CONDITIONS	13
9) TROUBLESHOOTING	—
10) EQUIPMENT DISPOSAL	—
11) USEFUL CONTACTS	—

SAFETY REQUIREMENTS



ATTENTION:

Read the manual carefully before starting to use the control unit. Keep the instructions for future reference.



Do not open the device, touching any internal components can cause electric shock. Contact with over 50 Volts can be fatal. To reduce the risk of electric shock, do not dismantle the device for any reason. Moreover its opening would void the warranty.

Before connecting the device to the power supply, make sure that all the connections are correct. Always disconnect the unit from the supply before any cabling modification.



Any intervention on the equipment must be entrusted to a qualified engineer.

Failure to comply with these instructions can cause damages, fires or electric shock, and possible serious injuries!

POWER SUPPLY

The T119 DIN control unit has UNIVERSAL power supply, i.e. it can be supplied by 24 to 240 Vac-Vdc, irrespectively of polarity in Vdc.

Before using it, make sure the power cable is not damaged, knotted or pinched. Do not tamper with the power cable. Never disconnect the unit by pulling the cable, avoid touching the pins. Do not carry out any connecting/disconnecting with wet hands. To disconnect the device, do not use objects such as levers. Immediately disconnect the device if you smell burning or see any smoke: contact technical service.

LIQUIDS

Do not expose the equipment to splashes or drops, do not position it in places with humidity exceeding 90% and never touch with wet or humid hands. If any liquid penetrates the control unit, disconnect it immediately and contact technical service.

CLEANING

Disconnect the power cable before cleaning the control unit, use a dry cloth to dust it, without any solvent or detergents, and compressed air.

OBJECTS

Never insert any objects into the cracks of the control unit. If this happens, disconnect the control unit and contact an engineer.

USE RESERVED TO QUALIFIED PERSONNEL

The purchased goods are a sophisticated electronic device that is totally unsuitable to be used by non-qualified personnel. Any work must be carried out by a specialist engineer.

ACCESSORIES

The use of non-original accessories or spare parts can damage the unit and endanger user safety. In the event of faults, contact technical service.

LOCATION

Install the control unit indoors, in a place protected from water splashes and sun rays. Do not place near heat sources exceeding the parameters stated in this manual. Position on a stable surface, far from any possible vibrations. Position the unit as far as possible from any intense magnetic fields.

REPAIRS

Do not open the control unit. For any fault, always use qualified personnel. The opening of the control unit and/or the removal of the series identifying label entails the automatic forfeiture of the warranty. The Warranty seal is applied to all devices, any attempt to open the unit would break the seal and cause the consequent automatic forfeiture of the warranty.

TECHNICAL INFORMATION

Mail: ufficiotecnico@tecsystem.it — tel: 02/4581861

ACCESSORIES

The following objects are present inside the box:

Control unit

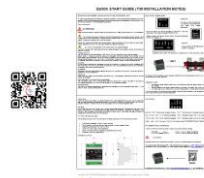
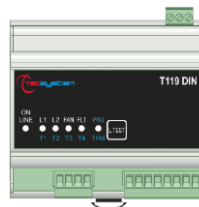

1 supply terminal 3 poles pitch 5
Code: 2PL0367 - Screws tightening torque 0.5Nm



1 PTC sensor terminal 4 poles pitch 5
Code: 2PL0369 - Screws tightening torque 0.5Nm



1 relay terminal 8 poles pitch 5
Code: 2PL0374 - Screws tightening torque 0.5Nm



1MN0030 REV. 0

ATTENTION: always install the device using the terminals included in the pack.
The use of terminals other than those included with the control unit might cause malfunctions.

TECHNICAL SPECIFICATIONS

T119DIN

POWER SUPPLY

Supply rated values

24 -240Vac-dc
50/60HZ

Maximum ratings 20-270 Vac-dc

•

Vdc with reversible polarities

•

INPUTS

3 series of PTC inputs

•

1 series for L1 (ALL1)

•

1 series for L2 (ALL2)

•

1 series for FAN

•

Connections to removable terminals

•

Input channels protected against electromagnetic interference

•

OUTPUTS

2 alarm relay (ALL1 / FAULT AND ALL2) SPDT

•

1 ventilation management relay (FAN) with timed latch (5-10-20-40 min.) delay OFF SPST

•

Output relays with 5A-250Vac-res COS Φ =1 contacts

•

DIMENSIONS

106x95 mm depth 62mm DIN EN50022

TESTS AND PERFORMANCES

•

Construction in accordance with CE regulations

•

Protection from electrical interference EN 61000-4-4

•

Dielectric strength 1500 Vac for a min. between output relays and sensors, relays and power supply, power supply and sensors

•

Ambient operating temperature from -20°C to + 60°C

•

Humidity 90% non-condensing

•

BLEND PC/ABS housing

•

TECHNICAL SPECIFICATIONS	T119DIN
Absorption 2 VA	•
Self-diagnostic circuit	•
Protection treatment of the electronic part	Option
DISPLAY AND DATA MANAGEMENT	
LED indicating alarm channel, trip or fan	•
LED indicating FAULT	•
2 alarm thresholds	•
1 ventilation control ON threshold	•
Access to programming through keyboard	•
Automatic exit from programming after 1 minute's inactivity	•

INTRODUCTION

The T119 DIN is the most advanced unit on the market as regards temperature monitoring units for MV cast resin transformers which utilize PTC sensors.

The unit gives the L1 pre-alarm and L2 alarm-trip signals when the temperature limits sensed by the PTCs in the coils are reached.

The T119 DIN is set to control the cooling ventilation of the transformer. The T119 DIN continuously monitors the efficiency of the PTC sensors and when one of these fails, an immediate alarm signal of faulty sensor is sent.

The FAN relay is energized so long as the temperature T° is higher than the δNAT value; when T° gets below this value, the relay is still energized for the set ventilation time (5-10-20-40') (DELAY OFF function).

As the PTCs currently produced by the various European manufacturers have different specifications, Tecsystem Srl is not responsible for the control system malfunctioning due to PTCs with resistance values other than those indicated in **table 1**.

FRONT

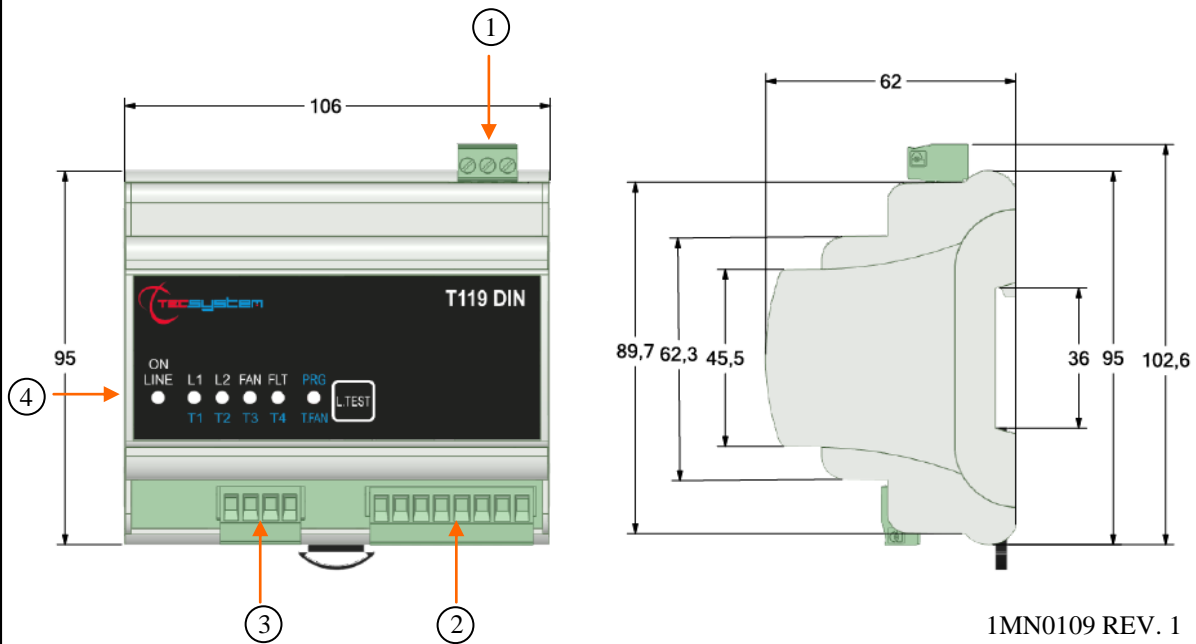

1MN0109 REV. 1

1)	Universal unit supply 24-240 Vac-dc 50/60Hz.	3)	L1 - L2 - FAN PTC sensor lines
2)	Relays (ALARM/FAULT- ALL2)	4)	Device operation LED (ON-L1-L2-FAN -FAULT)

LED SIGNAL:

LED ON: "ON" The device is powered correctly "OFF" The device is not powered correctly

L1 LED:

"ON" L1 trip threshold exceeded, "OFF" temperature below the L1 trip threshold.

L2 LED:

"ON" L2 trip threshold exceeded, "OFF" temperature below the L2 trip threshold.

FAN LED:

"ON" FAN trip threshold exceeded, "OFF" temperature below the FAN trip threshold.

FAULT LED - L1 LED - L2 LED - FAN LED flashing, see **PTC SENSOR FAULT DIAGNOSIS** on page 10.

POWER SUPPLY

The T119 DIN control unit has UNIVERSAL power supply, i.e. it can be supplied by 24 to 240 Vac-Vdc, 50/60 Hz irrespectively of polarity in Vdc (terminals 40-42).

This is obtained thanks to the use of a tested power supply unit, newly designed and manufactured, that frees installers from worrying about the correct Vac or Vdc supply.

The ground cable must always be connected to terminal 41.

When the unit is supplied directly by the secondary of the transformer to protect, it can be burnt out by strong overvoltages. This happens if the main switch is closed and the transformer has no load (blank test).







The above-mentioned problems are much more evident when the 220 Vac voltage is taken directly from the transformer secondary bars and there is a fixed capacitor battery to phase the transformer itself.

To protect the control unit from line overvoltages, we suggest using the PT-73- 220 electronic discharger, designed by TECSYSTEM S.r.l. for this specific purpose. As an alternative we suggest using supply voltages from 110 Vac or, much better, 110 Vdc.

If an existing control unit must be replaced with a new one, to guarantee its correct and safe operation, the sensor/relay/supply connecting terminals must be replaced with the new terminals supplied.

PROGRAMMING

FAN PROGRAMMING CYCLE

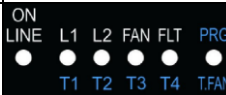
STEP	ACTION		EFFECT	
1	Turn on the unit		the green LED lights up	
2	Push TEST twice in sequence		the red PRG LED flashes	
3	Push TEST within 5" without releasing it until the PRG LED is ON		the PRG LED is ON continuously	
4	Push TEST within 5" to select the desired FAN time		the red/yellow LED switches from T1-T2-T3-T4 (FAN time 5'-10'-20'-40')	
5	Stop pressing TEST when the LED is on the Tx corresponding to the desired time. Wait for all the LEDs to go OFF.			
6	End of programming		all the LEDs are switched OFF	
7	Turn the unit off and then back on			

To choose the FAN time (point 4):

Press TEST once to select **5'** (T1 ON)





Press TEST twice to select **10'** (T2 ON)

Press TEST three times to select **20'** (T3 ON)

Press TEST four times to select **40'** (T4 ON)

If you don't need any FAN cycle, push TEST 5 times (all LEDs are OFF). The unit is programmed only for ALL1 and ALL2 (alarm and trip)

ALARM RELAY TEST

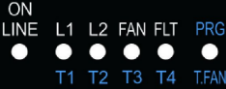
STEP	ACTION		EFFECT	
1	Push TEST three times in sequence		the T1,2,3,4 LEDs light up in sequence	
2	Within 5" push TEST without releasing it until the LEDs light up all together		LEDs T1,2,3,4 flash all together	
3	After 5" the relay FAN lights up, followed by the ALL1 and ALL2 relays		the LEDs and relays of ALL1-ALL2-FAN are ON	
4	END OF THE TEST CYCLE		all the red LEDs go OFF	

LED TEST

We recommend the unit LEDs are tested regularly. For this operation press the TEST button briefly, all the leds light up for 2 seconds.

If one of the LED does not work, please return the control unit to TECSYSTEM for repair.

ALARM 1 RELAY OPERATION

The ALL1 (L1) relay operates when the unit is powered, therefore the N.O. contact is closed. In case of an alarm on the ALL1 (L1) PTC or a fault in the control unit itself, the relay gets de-energised with consequent closing of the N.C. contact.

The ALL1 (L1) relay also has the same function as the PTC sensor FAULT. If this relay is triggered when the PTC sensor FAULT LED is FLASHING, it means that there is an error in the reading of a PTC sensor. It is possible to find it, thanks to a second LED flashing which corresponds to the FAULT channel.

ALARM 2 RELAY OPERATION

The ALL2 (L2) relay is normally de-energized and energizes when there is an alarm on the L2 PTC.

FAN RELAY OPERATION (VENTILATION)

During programming, it is possible to set the cooling time or to exclude the FAN option. If the FAN is excluded, the relay doesn't energize and for this reason it is possible not to install the corresponding PTC.

If the FAN is set up, the relay activates when the relative PTC sends the first signal and the FAN LED is steady ON: the relay is active for as long as the PTC senses the temperature is normal, the T119 DIN unit keeps the relay ON for the time set during programming and the FAN LED flashes.

DELAYED VENTILATION CYCLE (DELAY ON)

STEP	ACTION	EFFECT	
1	The FAN PTC sensor is ON	the FAN relay is ON and the yellow LED is lit	FAN ● T3
2	The temperature goes below the PTC value	the FAN relay remains ON for the set time and the yellow LED flashes	FAN ● T3
3	The temperature raises again above the PTC set threshold	the LED is ON all the time	FAN ● T3



IMPORTANT WARNING

Before carrying out the isolation test of the electrical panel the control unit is installed on, disconnect it with the sensors from the power supply to prevent it from being seriously damaged.

SENSOR DIAGNOSTIC DEVICE

This new function allows enabling or disabling the PTC diagnostic device (Foc and Fcc):

Diagnostics disabling method:

power the instrument keeping the TEST button pressed until the FAULT LED comes ON

With the diagnostics **disabled**, the FAULT red LED will be ON all the time.

Diagnostics re-enabling method

Power the instrument keeping the TEST button pressed until all LEDs go OFF. With the diagnostics **enabled**, the FAULT red LED will be OFF and flash in case of sensor faults.

The T119 DIN control units will be supplied with the sensor diagnostics **ENABLED**.

PTC SENSOR FAULT

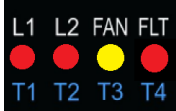
ACTION	EFFECT	
one of the PTCs is short-circuited	the FLT red LED and the corresponding LED (ALL1-ALL2-FAN) are flashing	
replace or repair the PTC	the LEDs go OFF	

PTC SENSOR FAULT DIAGNOSIS

If one of the PTCs is short-circuited or open you get the following warnings:

- PTC alarm ALL1(L1) The FAULT + ALL1 LEDs are flashing
- PTC TRIP release ALL2(L2) The FAULT + ALL2 LEDs are flashing
- PTC FAN FAN The FAULT +FAN LEDs are flashing



If the T119 DIN control unit is not connected to the correct PTC model, the LEDs flash. The PTC temperature is $\delta_{nat} + T = 1300 \text{ ohm}$.

"PTC" TYPE TEMPERATURE SENSORS

The PTCs can be compared to bimetallic thermostats where the contact opens and closes at the approximate temperature, defined as their operating characteristic (δ_{NAT} =operating temperature).

The sensor is calibrated for one temperature only that can vary from 60°C to 190°C, in 10°C (In relation to the acquired probe), in 10°C steps (60-70-80-90-100-110-120-130-140-145-150-155-160-170-180-190).

The PTCs are electronic thermometric sensors made with a chemical mixture that vary their electrical resistance according to the recorded temperature.

There is a δ_{NAT} (operating temperature) for the PTCs as well as for the bimetallic thermostats. The PTCs do not allow precision adjustments since the characteristic resistance values are fixed at -5°C and $+5^{\circ}\text{K}$ of δ_{NAT} .

The PTC characteristic resistance values are set by the DIN 44081 and 44082 standards.

Since the PTC resistance curve is very rapid, in the section between $\delta_{NAT} -5^{\circ}\text{C}$ and $\delta_{NAT} +5^{\circ}\text{K}$, it is quite difficult to make adjustments in a temperature span of less than $\pm 5^{\circ}\text{K}$.

Table 1

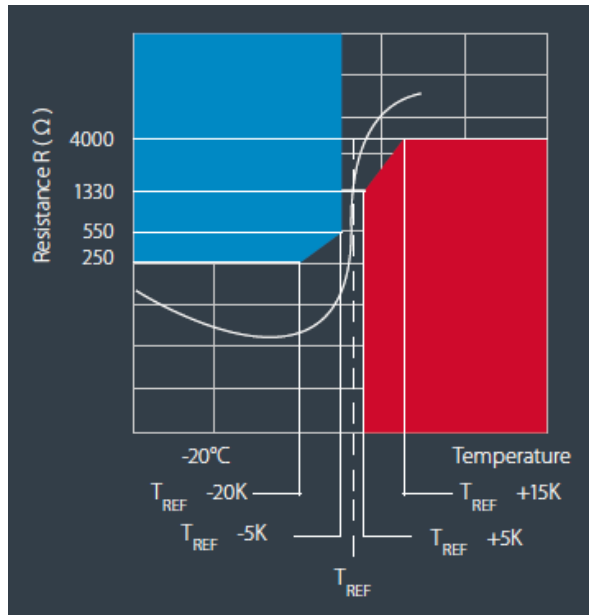

PTC TECHNICAL SPECIFICATIONS

TEMPERATURE	RESISTANCE Ω	MEASURED VDC VOLTAGE
-20°C to T _{REF} -20K	20 – 250 Ω	≤2,5V
Resistance T _{REF} -5K	≤550 Ω	≤2,5V
Resistance T _{REF} +5K	≥1330Ω	≤2,5V
Resistance T _{REF} +15K	≥4000Ω	≤7,5V pulsed
Electric stiffness		2500 Vac
Maximum operating voltage		30

PTC RESISTANCE VALUES ALLOWED FOR CONNECTION TO T119 DIN

The resistance value shown in table 1 refers to a single or multiple series of PTCs.

The correct operation of the device is obtained by complying with the stated resistance values. In case the single or multiple series of PTCs have resistance values other than the stated, please contact TECSYSTEM Srl - Technical Service.

FUNCTION	RESISTANCE
NO ALARM Temperature of the machine below the alarm thresholds	HIGHER THAN 50 Ω
ALARM Alarm thresholds reached for FAN-ALL-L1-TRIP-L2	HIGHER THAN 1800 Ω
FOC Sensor diagnostics interrupted	HIGHER THAN 10 KΩ
FCC Sensor diagnostics short-circuited	LOWER THAN 30 Ω

SENSOR / RELAY ELECTRICAL CONNECTIONS

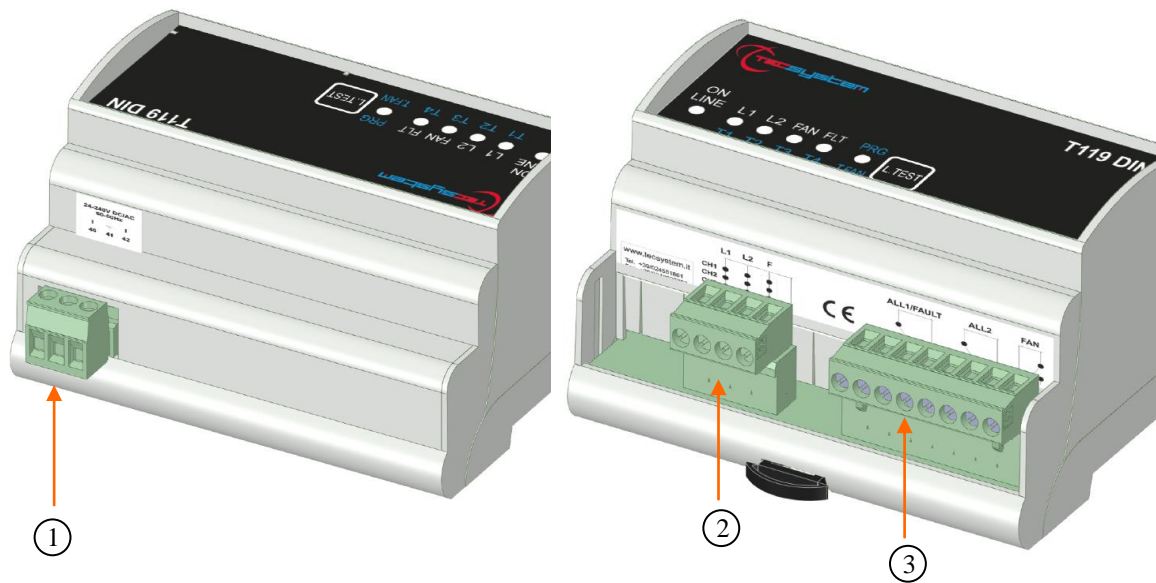

1MN0109 REV. 1

1)	Universal unit supply 24-240 Vac-dc 50/60Hz.	3)	Relays (ALL1/FAULT-ALL2-FAN)
2)	L1 - L2 - FAN PTC sensor lines		

PTC SENSORS

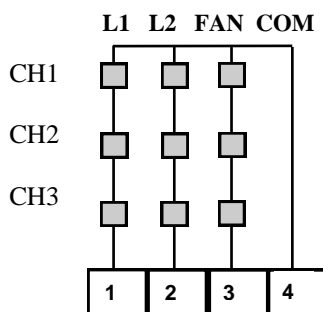

RELAYS

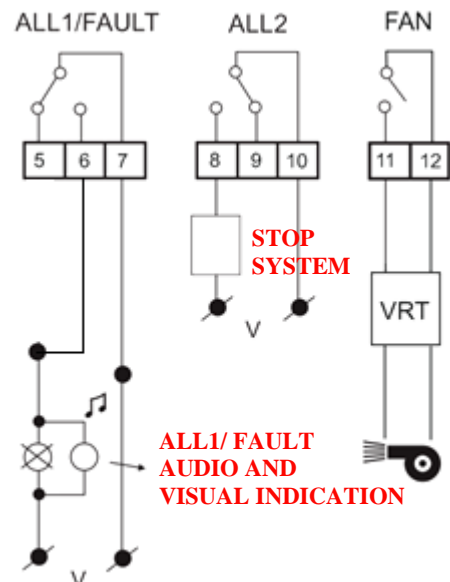

1MN0095 REV. 0

The ALL1 / FAULT relay operates normally when the unit is powered, therefore contact 5-7 is closed. The above picture shows the state of the relays in non-alarm condition.

WARRANTY CONDITIONS

The Product purchased is covered by the manufacturer's or seller's warranty at the terms and conditions set forth in the "Tecsystem s.r.l.'s General Conditions of Sale", available at www.tecsystem.it and / or purchase agreement.

The warranty is considered valid only when the product is damaged by causes attributable to TECSYSTEM srl, such as manufacturing or component defects.

The warranty is invalid if the Product proves to have been tampered with / modified or incorrectly connected and causing voltages outside the set limits and does not comply with the technical data for use and assembly, as described in this instruction manual.

The warranty is always ex Corsico as stated in the "General Conditions of Sale".



Tecsystem Srl is not responsible for damages caused by the monitoring unit due to PTC sensors which do not have the resistance features of the DIN44081 and 44082 standards.

N.B. To verify the correct operation of the monitoring unit in all its functions, we suggest you use the SIM-PTC simulator.

TROUBLESHOOTING	CAUSES AND SOLUTIONS
The control unit does not switch on, the corresponding LED is OFF.	Switch the unit off and check that: the connecting wires are tightened and there are no obvious burns on the connectors.
One of the two PTC lines is in FAULT alarm	Check the continuity and connection of the relative PTC line. Replace the faulty sensor, see PTC sensor fault diagnosis on page 10.

EQUIPMENT DISPOSAL

European directive 2012/19/UE (WEEE) has been approved to reduce electrical and electronic waste and promote the recycling and reuse of the materials and components of said equipment, cutting down on the disposal of the residues and harmful components of electrical and electronic materials.



All the electrical and electronic equipment supplied after 13 August 2005 is marked with this symbol, pursuant to European directive 2012/19/UE on electrical and electronic waste (WEEE). Any electrical or electronic equipment marked with this symbol must be disposed of separately from normal domestic waste.

Returning used electrical devices: contact TECSYSTEM or your TECSYSTEM agent for information on the correct disposal of the devices.

TECSYSTEM is aware of the impact its products have on the environment and asks its customers active support in the correct and environmentally-friendly disposal of its devices.

USEFUL CONTACTS

TECHNICAL INFORMATION : ufficiotecnico@tecsystem.it

SALES INFORMATION : info@tecsystem.it

